

# FENDT

FENDT 700 VARIO GEN7.1 SERIES



FENDT® 700 SERIES | 203 TO 283 RATED ENGINE HP

**YOU DREAMT IT.  
WE BUILT IT.**



**Fendt® 700 Vario Series at a Glance**

The Fendt 700 Vario series takes your operation to the next level no matter the season or application. The latest evolution brings together the incredibly adaptable and efficient design elements this series has been well renown for and pairs it with the innovative technological advancements that provide farmers with greater performance, efficiency, and agronomic benefits because It's Fendt!

Engine		720 Vario Gen7.1	722 Vario Gen7.1	724 Vario Gen7.1	726 Vario Gen7.1	728 Vario Gen7.1
Rated power ECE R 120	hp / kW	203 / 149	223 / 164	243 / 179	262 / 193	283 / 206
Maximum power with DP ECE R 120	hp / kW	223 / 164	243 / 179	262 / 193	282 / 206	303 / 223













**FENDT 700 VARIO GEN7.1 SERIES**





# FENDT 700 VARIO GEN7.1 SPOTLIGHTS.

Fendt spotlights are unique innovations that add incremental value to your operation and provide an unparalleled experience.

-  **Fendt iD™ low engine speed concept** *(page 10)*
  - 700–1,700 engine RPMs
  - Higher torque generated at lower engine RPMs
  - Smooth, quiet operation
-  **Fendt VarioDrive CVT** *(page 9)*
  - Seamless operation from 65 ft. per/hr to 31 mph
  - Independent drive of front and rear axle to reduce slip
  - No manual all-wheel drive selection necessary
  - Optimum engine/transmission matching in conjunction with Fendt iD
  - low-speed concept
  - No range changes
-  **Dedicated and adaptable Hydraulics** *(page 13)*
  - Up to 58 GPM fully dedicated system
  - Optional front 3pt., PTO, and hydraulics
  - Assignable and customizable from the cab
-  **VarioGrip** *(page 11)*
  - Optional integrated tire pressure control system
  - Reduces compaction, tire wear, and improves ride quality
-  **Unparalleled Ride Quality** *(page 8)*
  - Racecar influenced, self-leveling front-axle suspension
  - Pneumatic cab suspension
  - Optional premium seat that includes massage function, memory settings, and its adjustments made through the FendtONE displays
-  **FendtONE™** *(page 6)*
  - Dual 12" displays (2nd retractable display is optional)
  - Multi-function joystick and ergonomic armrest design
  - Completely customizable
-  **Fendt Stability Control** *(page 12)*
  - Automatically reduces side lean at speeds above 12 mph
  - Actively suppresses body roll when cornering
  - Improved ride comfort
-  **Concentric Air System (CAS)** *(page 10)*
  - Concentric, forced air fan with independent, hydraulic drive
  - Extremely narrow compact fan enables outstanding visibility and a tight steering angle
  - Extremely efficient: up to 40% less drive power than standard fans
  - Reversible fan option
-  **Intelligence that Extends Beyond the Tractor** *(page 20)*
  - The optional CargoProfi loader takes loader operation and comfort to a whole new level with dampening suspension, memory settings, and an integrated scale feature
-  **Gold Star Customer Care** *(page 21)*
  - Standard 3 year or 3,000 hour full machine warranty PLUS all scheduled maintenance and a loaner guarantee

# CUSTOMIZE. ORGANIZE. OPTIMIZE.



**FendtONE is much more than just a cab. It allows you to completely customize your settings, data management, and operating environment to suit your needs.**

- Incorporates up to three display options:
  - Standard 10" digital dashboard
  - Standard 12" terminal on the armrest
  - Optional secondary 12" terminal that stows partially into the roof liner
- Customizable terminal layout
- Redesigned multi-function joystick that is highly customizable
- Flexible key assignment with Individual Operation Manager (IOM)
- Color-coded controls for similar functions
- Infotainment: hands-free Bluetooth® and audio control system integrated in terminals
- Integrated NovAtel or Trimble® receivers

- 
- 1** As well as the familiar clover leaf operation, the new multifunction joystick includes two controls for proportional valve control as well as four freely assignable white keypads.
- 2** This is where you can easily manage the usual transmission and driving functions with pushbuttons: including two engine speed programs, two cruise control settings and a new dial-controlled active cruise control setting.
- 3** The 3L joystick offers precise control without having to reach over two control valves. Complex implement functions can be controlled with the optional third and fourth hydraulic circuits. The 3<sup>rd</sup> and 4<sup>th</sup> functions are operated via the smaller, thumb joystick.
- 4** Hydraulic Valve LED Displays indicate assigned valve color and status. The operator immediately sees valve allocation and status for error free operation.

- 5** PTO Operation
- 6** In the middle operating level, from the left foot pedal max, we have the following: hand throttle, speed spread, adjustment SCVs 1 through 4 (freely assignable), PTO actuation as well as front power lifts and rear power lifts with depth adjustment.
- 7** Here are buttons for rear and front 3 point control, and in the middle the five freely assignable white buttons.

- 8** Use the central pushdial to decide what to display on the Fendt 700 Vario. This includes four quick access keys for Back, Launchpad, Overview, Individual Operation Manager (IOM) and switching between terminal and dashboard.
- 9** Easily manage the air conditioning and infotainment with two dedicated dials.





### New Premium Driver's Seat

- An optional premium driver's seat takes comfort to the next level
- Electric adjustment of the backrest, side bolsters and lumbar support; electric longitudinal adjustment
- Massage function
- Multi-stage seat heating and air conditioning
- Memory function
- Operating and setting the seats comfort functions done via the FendtONE terminal

### Optional Carbon Activated Filter



### Cab Suspension Options

- Pneumatic (*standard*): two conical bearings at the front, two pneumatic spring elements at the rear
- Pneumatic comfort (*optional*): 3-fold pneumatic (*pneumatically suspended, central swing arm at the front and two pneumatic suspension elements at the rear*).
- Outstanding suspension comfort due to perfect interaction of cab, seat and front axle suspension as well as vibration dampening.



### Infotainment bundle with 4.1 sound system

- Four high-end speakers and a subwoofer deliver superior sound quality in the VisioPlus cab. Enjoy playback from your smartphone via USB, AUX-IN and Bluetooth®. FM/AM/HD and two antennas with permanent channel search also ensure uninterrupted radio reception.
- Eight microphones installed in the roof liner mean your hands are free and the acoustics are perfect.

# THE HEART AND SOUL OF EVERY FENDT TRACTOR.



## VarioDrive CVT

Seamless, smooth control from 65 ft. per hour to 31 mph, the Fendt VarioDrive CVT drives like nothing else you've experienced. The innovative design of the transmission provides ideal torque distribution to front and rear wheels for optimal traction and tractive power.

The drive train is based on a hydraulic pump and two hydro motors. The first hydro motor supplies the rear axle with uninterrupted torque via hydrostatic-mechanical power, splitting from 0 mph to 31 mph, and the second hydro motor powers the front axle. It's because of this innovative design that the system will automatically divert power between the axles for optimum pulling power and reduce slip. Operate the transmission in either joystick or pedal modes to best suit your needs.

# THE NEXT EVOLUTION OF EFFICIENCY IS HERE.



## Fendt iD Low Engine Speed Concept

The Fendt iD low engine speed concept allows you to do more of everything, while consuming less. With an RPM band of just 700–1,700 and peak torque achieved and sustained from 1,100–1,400 RPMs, you consume a lot less fuel, while covering more ground, more efficiently.

Not to mention that the system also provides for an incredibly smooth and quiet operating experience and better longevity out of the engine.

## Fendt DynamicPerformance: intelligent multi-performance concept

- Up to 20 hp more power regardless of driving speed
- Compared to conventional boost concepts, DP extra power is also available when cultivating and when stationary
- Perfect power to weight ratio
- Less fuel consumption

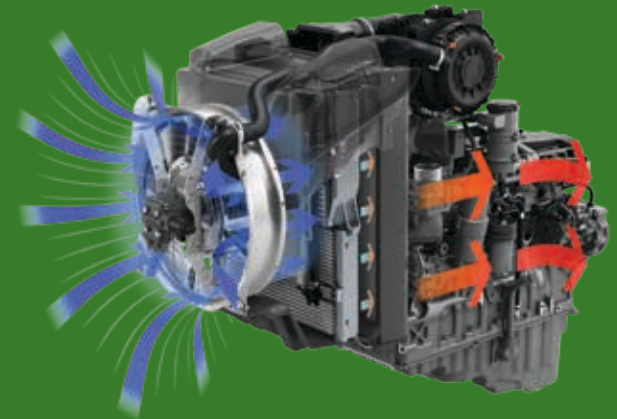

*The Concentric Air System (CAS) cooling concept with forced-draft high-performance fan cools all heat exchangers accordingly and further increases overall efficiency.*

# MORE GRIP. LESS SLIP.



*An onboard air compressor supplies air lines that are integrated into the wheel assembly. All components are secure and covered to prevent damage.*

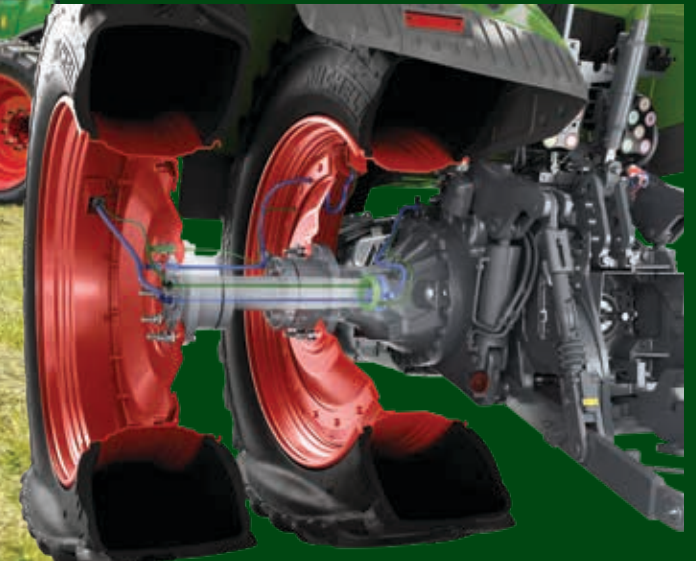

**You shouldn't sacrifice soil health for machine performance and with Fendt, you won't.**

VarioGrip™ is an optional factory installed tire pressure control system that allows the operator to set and control tire pressure from the FendtONE displays. This reduces compaction while in the field, improves ride quality whether roading or in the field, and reduces tire wear.

Compared to working with unadjusted tire pressure, you can achieve up to 10% more pulling power and cover up to 8% more area with up to 8% lower fuel consumption.\* VarioGrip is available for flange and bar axles, and with either single metric or dual tire configurations.

\* Test results from South Westphalia University of Applied Sciences, Faculty of Agriculture, Soest.



**Varioactive steering** reduces operator input and fatigue by requiring only a proportional turn of the steering wheel to achieve maximum steering angles. Steering sensitivity can easily be set and adjusted from the FendtONE displays.



**Fendt Stability Control (FSC)** takes steering precision, driving stability and braking control to new levels. At speeds above 12.4 mph (20 km/h), FSC locks the front axle suspension cylinders and dampens side-to-side movement to ensure maximum stability in transport. When speeds drop below the FSC threshold, it automatically disengages to ensure maximum ground contact with all four tires.



### Trailer Brake Assist

- Performance and comfort feature which ensures that a pneumatically braked trailer doesn't "push" against the tractor
- Continuous monitoring of the trailer's thrust on the tractor
- Brake pressure is automatically controlled in critical situations without the need to press the brake pedal.

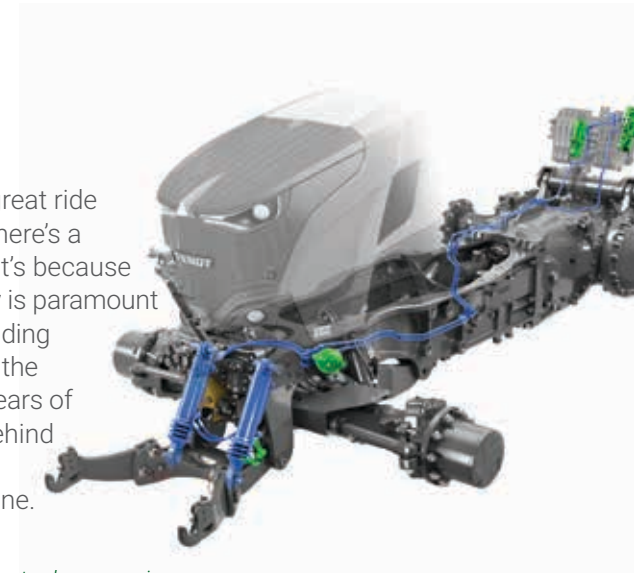

There's a great ride and then there's a Fendt. That's because ride quality is paramount when spending months of the year and years of your life behind the wheel of a machine.

*Self-leveling front-axle suspension provides a better ride and tractive ability.*

You'll never come up short with the Fendt hydraulic system. With up to 58 gallons per minute of dedicated hydraulic capacity, the Fendt 700 gives you the adaptability to work in multiple applications, no matter the demand.

The hydraulic system is completely independent from other hydraulic consumers, such as transmission or steering functions. This ensures you have complete power and accuracy all the time and eliminates cross contamination.



Color coordinated hydraulic outlets allow you to reassign the remotes from the FendtONE displays in the cab. As a result, you won't need to hop out and re-plug hydraulic hoses if mistakenly plugged into another outlet.

You can order up to 5 rear hydraulic valves plus power beyond.

Modular hydraulic coupling system: DUDK or flat-face FFC couplings options provide less pressure loss, reduced consumption, leak-free.

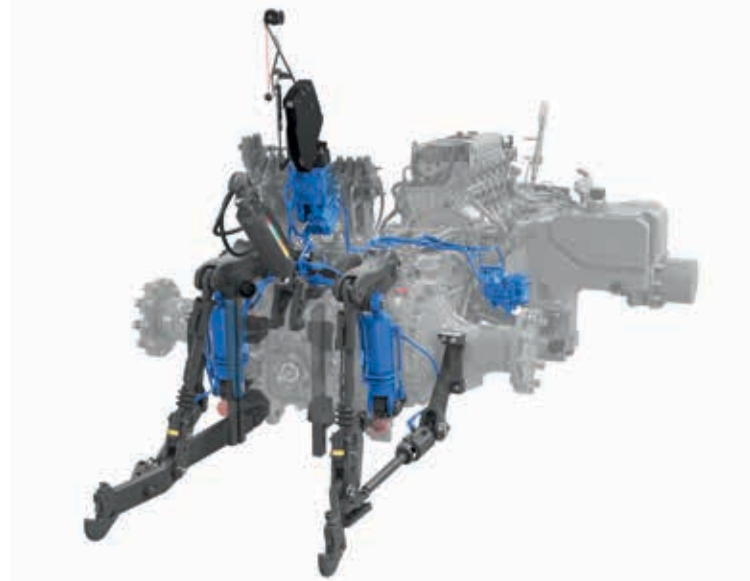
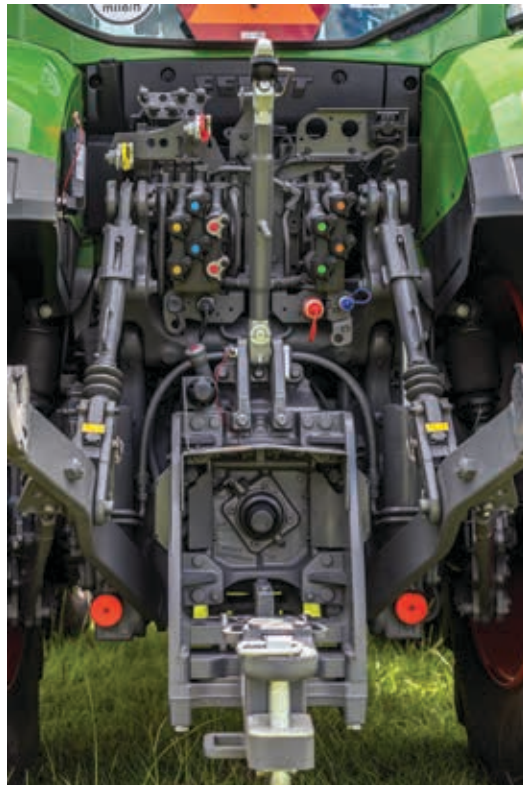

The rear 3-point features 24,000 lbs. of lift capacity and vibration dampening for smooth, easy transport.

Its relief control system eliminates the need for operator re-adjustment of the implement and smoothly follows the changing terrain of the ground.



**1. Front Linkage:**

- High max. lifting force: 11,900 lbs. continuous lifting force
- Leakage oil reservoir for auxiliary control units integrated in lower link frame
- Easy attachment of implements with camera in the hood (*optional*)

**Variants:**

- Without front linkage
- Comfort ballast weight support
- Front linkage (single acting) Cat. 2 with position control
- Comfort front linkage (*double acting*) Cat. 2 with position control and load relief control



**Benefits**

- + **Integrated design, foldable/removable**
- + **High lifting capacity for a wide range of applications**
- + **No restrictions on the working hydraulics (own hydraulic valve)**
- + **Vibration damping**
- + **External operation**
- + **Simple operation and adjustment via linkage operating module and terminal**
- + **Relieving control for front mower use without additional relief springs or optimum steering ability**

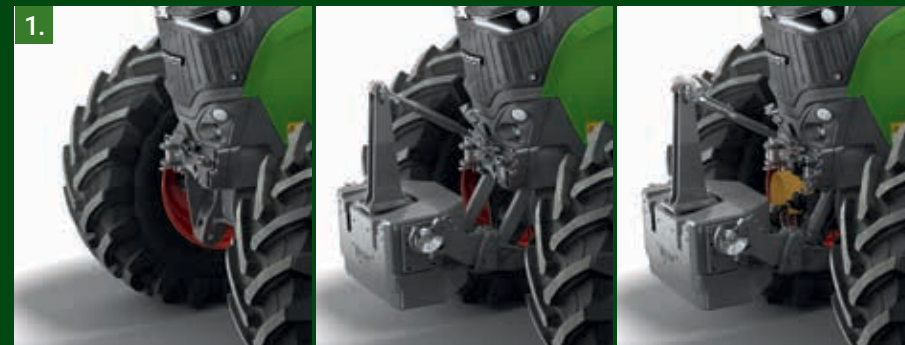

Without front linkage

Comfort ballast support

Front linkage Cat. 2

## 2. Comfort front linkage with position control and load relief control

- Active regulation of the relief pressure
- Load relief effect adjustable thanks to pressure relief valve
- Simple and convenient setting of the relief effect in the terminal
- Position sensor on front linkage for detecting unevenness
- No mower relief springs necessary



- + Enables work that is gentle on the equipment
- + Optimum ground hugging, thus protecting the implement when mowing and less forage contamination/higher forage quality
- + Ensuring directional stability by loading the front axle depending on the area of use

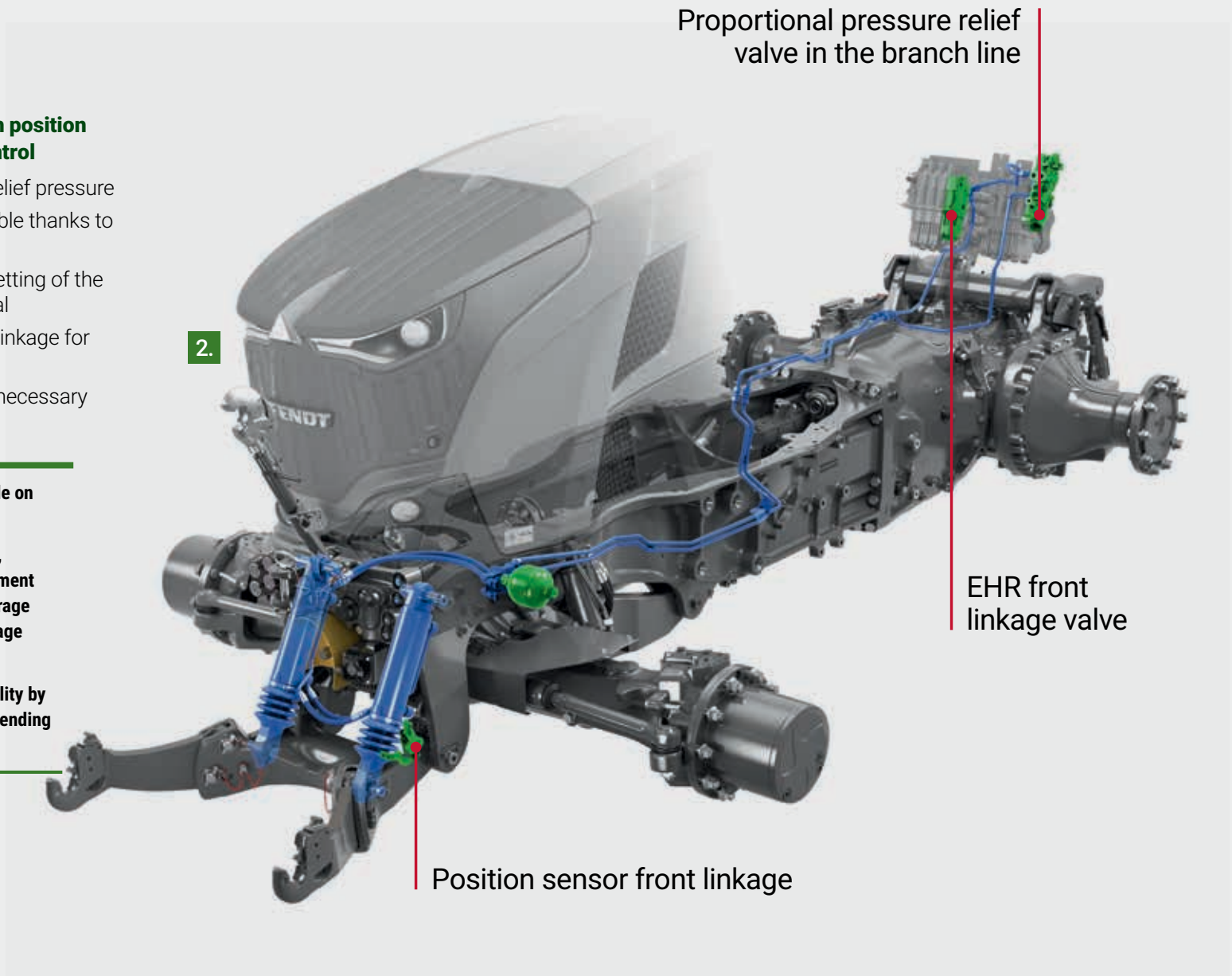

Proportional pressure relief valve in the branch line

2.

EHR front linkage valve

Position sensor front linkage

# FENDT GUIDE AUTO STEERING AND HEADLAND MANAGEMENT.

For those who prefer precision.

You can configure your Fendt guidance system to suit your needs. Equip your system with either a Trimble® or NovAtel® satellite receiver. Depending on your work and individual requirements, you can choose from correction signals with different accuracy levels.

## Trimble receiver



6-12 in

### Trimble Standard

Correction signal: SBAS (EGNOS & WAAS)

± 6-12 inches track-to-track accuracy; ± 59 inches repeatable accuracy

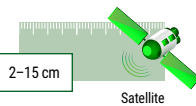

### Trimble – extendible correction signals

Correction signal: RangePoint® RTX

± 6 inches track to track accuracy; ± 19.7 inches repeatable accuracy

Correction signal: CenterPoint® RTX and CenterPoint RTX Fast

± <1 inch track to track accuracy; ± <1 inch repeatable accuracy

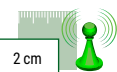

### RTK

Correction signal: RTK

± <1 inch track to track accuracy; ± <1 inch repeatable accuracy

Mobile network / radio

## NovAtel receiver



6-12 in

### NovAtel Standard

Correction signal: SBAS (EGNOS & WAAS)

± 6-12 inches track-to-track accuracy; ± 59 inches repeatable accuracy

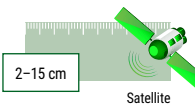

### NovAtel – extendible correction signals

Correction signal: TerraStar-L

± 6 inches track to track accuracy; ± 19.7 inches repeatable accuracy

Correction signal: TerraStar-C Pro

± <1 inch track to track accuracy; ± <1 inch repeatable accuracy

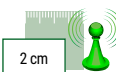

### RTK

Correction signal: RTK

± <1 inch track to track accuracy; ± <1 inch repeatable accuracy

Mobile network / radio

Because the receivers are installed under the roof hatch, they are fully protected against theft, weather and damage.

Two main factors are decisive for farming:

- Track-to-track accuracy: Shows how precise the contacts are from one track to the next
- Repeatable accuracy: Specifies how accurately you can repeat an existing wayline or field boundary from the previous year

## Headland Management Made Easy with Fendt TI and TI Auto

This smart assist is a real benefit for repeat processes, especially headlands. Our Fendt TI headland management system saves you up to 1,920 daily hand movements in 160 turns. Both manually at a standstill and while driving, you can record all the functions as a sequence and save them in the terminal. Later, all it takes is a touch of a button to activate the automated sequences when entering and coming out of the headland. Work without having to reposition. Five triggers (route, time, front power lift, rear power lift and manual) and 13 function groups help you control an impressive 74 functions. Shift smoothly between the individual sequence steps. Later, all it takes is a touch of a key to activate the automated sequences at the headland.

With Fendt TI in combination with Fendt Guide (*Fendt TI Auto*), position detection automatically initiates all recorded steps at the headland.

## Work Profiles for Perfectly Adjusted Equipment, Even With Different Operators Working on the Same Machine

With the work profiles, you can save each implement with its own settings. This saves you from having to enter the settings each time. Even if you have different operators, they can then work efficiently and optimized without adjusting any settings. The numerous setting parameters include: power lift, PTO, hydraulics, maximum load control, cruise control, engine speed, and differential locks.

# AGRONOMY. SAVE TIME IN THE OFFICE.



## Fendt TaskDoc: Get Ahead of the Paperwork

With the order-led documentation system Fendt TaskDoc®, your tractor collects all necessary data as you work. You can then transfer the data as a standardized file into a field map—either via a USB stick, Bluetooth or wirelessly over the mobile network.

# MACHINE CONTROL. PERFECT INTERACTION OF TRACTOR AND IMPLEMENT.



## SectionControl (SC)

*SectionControl ensures accurate seed or product placement based upon coverage maps.*



## Perfect interplay via ISOBUS:

*SectionControl, VariableRateControl and the Fendt Guide Contour Assistant give you all the software you need for high-precision, quality work.*

Fendt ISOBUS is a standardized plug & play interface between the tractor and the attachment: Simply connect the ISOBUS plug to the ISOBUS socket, and the control screen of the attachment appears in the terminal.

## Pinpoint precision: Fendt SectionControl

SectionControl provides automated section control for ISOBUS implements. Fendt SectionControl supports up to 36 partial widths. The ISOBUS standard promises intuitive handling: The control screen automatically appears on the terminal when you connect the ISOBUS plug to the socket. All you need to do is activate a switch to start.

## How you benefit from Fendt SectionControl

- Savings of up to 15% in resources by avoiding unwanted overlaps
- Reduces the threat of disease, pests and weeds by avoiding overly dense crops and missed sections
- Less effort for the driver, so they can fully concentrate on monitoring the implement
- Improves the quality of work with automatic and accurate swath control
- Headland mode: Option to work the inner field first, then the headland

## Make full use of your tractor's potential: Fendt VariableRateControl (VRC)

VRC controls the output volume of resources (*seeds, pesticides, fertilizers*) for each subsection of field. To benefit from this smart solution, you need Fendt TaskDoc and an ISOBUS TC-GEO standard license.

## The advantages of Fendt VariableRateControl

- Increase your efficiency: Maximize yield while saving resources
- Save time: Use the job report as a reporting basis
- Flexibility: Compatible with ISO XML and Shape files

### No need for an external ISOBUS display

The optional 12" roof terminal offers you even more display space. You can show your ISOBUS attachment data on the roof display, for example, while the display on the armrest shows the lane guidance. External displays are no longer needed.



### Fendt Guide Contour Assistant

The Fendt Guide Contour Assistant option adds Contour Segments and Single Track to the familiar wayline types.

### Contour Segments Wayline

Record each segment and track everything, or apply them directly from the existing field boundary.

- No need to record different waylines to edit different sections of the field
- No need to manually switch between waylines as you work the field
- Combine all relevant tracks in one
- Contour Assistant automatically detects the right track

### Single Track Wayline

Record an almost endless track with an open contour.

- Ideal for plant protection, as you can record a single track and apply it to the whole field

# TELEMETRY. OPTIMIZE YOUR MACHINE USE.



### Call up machine data from any location: Fendt Connect

Fendt Connect is the central telemetry solution for Fendt machines. With Fendt Connect, machine data is collected and evaluated, so farmers and contractors can monitor, analyze and optimize the condition and use of their machines.

### Fendt Connect tells you about:

- Machine position and route
- Fuel consumption and DEF level
- Speed and working time
- Machine capacity
- Error messages
  - Upcoming service intervals

#### Fendt Connect

*Mobile data transmission means you can check your realtime machine data anywhere—from a PC, tablet or smartphone.*



# INTELLIGENCE THAT EXTENDS BEYOND THE TRACTOR.

## Fendt Cargo 6.100 at a Glance

- New front loader generation with a continuous lift capacity of 7,710 lbs. and a max. lift capacity of 9,100 lbs., 15.9 ft. lift height and a swing arm width of 45" for superior loading performance combined with extreme maneuverability in the 300 hp class.
- New multi-coupler:
  - 4-hose/6-hose compatible with each other
  - Less pressure loss
  - Dirt cover
- Own valve block with 3 separate valves (*no shared lines*)
- New universal bucket with 100" width and reinforced interface available

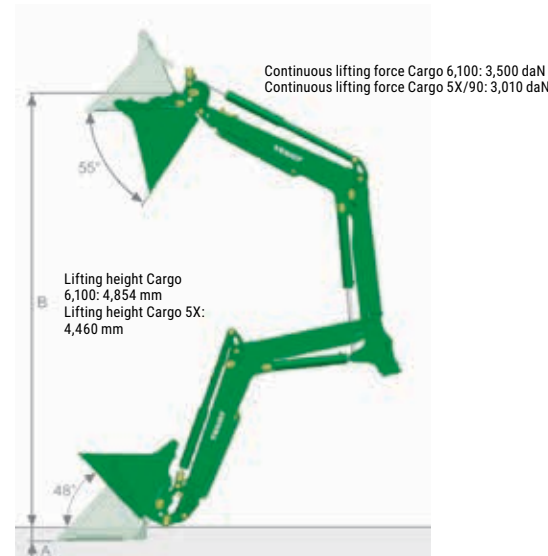
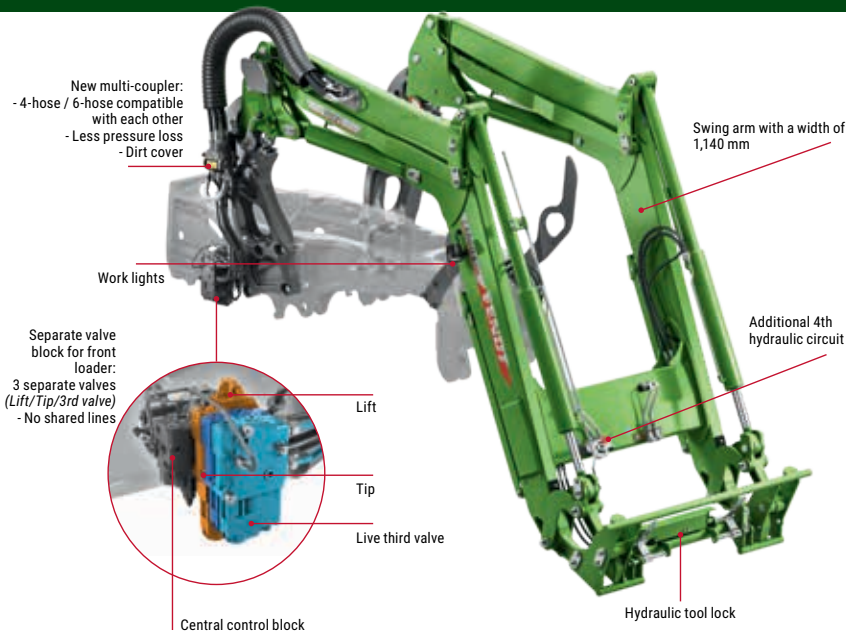

## CargoProfi Features

- Integrated weighing function in each position (*individual and total weight*)
- Limitation of the working range (*lifting height and tipping angle*)
- Memo function (*storage of boom and tool position*)
- Maintenance display of service intervals via the terminal
- Shaking function (*for shaking out sticky loads*)
- End position damping (*minimisation of trickle losses*)

# THE BOTTOM LINE: WE CARE ABOUT YOURS.



## GOLD STAR CUSTOMER CARE

Fendt's Gold Star Customer Care and its three-year warranty is the best in the business. Full-service inspections. No surprise maintenance costs. Best-in-class parts availability in North America. Uptime assurance with a loaner guarantee. And, exceptional resale value when you trade in your tractor for a newer model.

### The Warranty

Three years or 3,000 hours, including all scheduled routine maintenance and all other repairs, as required.

### The Parts

Fendt dealers use only genuine AGCO® parts, so your Fendt is always 100% Fendt. All parts are covered for one year, and all labor for six months, under the AGCO Parts Advantage warranty.

### The Operations Software

Starting with Model Year 2026, Fendt tractors will come with a 3-year PTx FarmENGAGE™ Operations license included with the Gold Star Customer Care package.



\*Two full 24 hour days

### The Service

Fendt dealers and their certified technicians use only the highest-caliber diagnostic tools.

### The Loaner

If your tractor can't be repaired in 48 working hours\*, we'll provide you a loaner tractor. We stand by this promise for three years or 3,000 hours.



## GOLD STAR+ CUSTOMER CARE

### Gold Star+ (Optional)

For longer working periods, you can extend the standard Gold Star offering with Gold Star+. All the same benefits but for as long as five years or 5,000 hours.

# SPECIFICATIONS

		720 Vario	722 Vario	724 Vario	726 Vario	728 Vario
<b>Engine</b>						
Rated power ECE R 120	HP/kW	203 / 149	223 / 164	243 / 179	262 / 193	283 / 206
Maximum power ECE R 120	HP/kW	203 / 149	223 / 164	243 / 179	262 / 193	283 / 206
Maximum power DP ECE R 120	HP/kW	223 / 164	243 / 179	262 / 193	282 / 206	303 / 223
PTO HP	HP/kW	185 / 138	201 / 150	219 / 163	237 / 174	254 / 190
Number of cylinders	Number	6				
Cylinder bore/stroke	mm	110 / 132				
Cubic capacity	in3/cm3	459.3 / 7,527				
Rated speed	rpm	1,700				
Max. Torque at 1300 rpm	ft-lbs/Nm	803 / 1,090	848 / 1,150	900 / 1,220	972 / 1,318	1069 / 1,450
Torque rise	%	30.0	25.0	21.0	21.0	16.0
Fuel tank	Gal / L	118.9 / 450				
DEF tank	Gal / L	14.5 / 54.9				
Exhaust gas treatment		DOC/DPF/SCR				
<b>Transmission &amp; PTO</b>						
Transmission type		ML 190				
Drive range forward	mph / km/h	65 ft./hr. to 31 mph / 0.02 km/h to 50 km/h				
Drive range reverse	mph / km/h	65 ft./hr. to 20.5 mph / 0.02 km/h to 33 km/h				
Rear PTO		540 / 540E / 1000 / 1000E				
Front PTO option		1,000				
Engine speed for rear PTO (540 PTO)	rpm	1,618				
Engine speed for rear PTO (540E PTO)	rpm	1,283				
Engine speed for rear PTO (1,000 PTO)	rpm	1,649				
Engine speed for rear PTO (1,000E PTO)	rpm	1,308				
Engine speed for front PTO (1,000 PTO)	rpm	1,647				
<b>Linkage &amp; Hydraulics</b>						
Variable displacement pump	gpm / lpm	43.6 / 165				
Variable displacement pump Option	gpm / lpm	58.1 / 220				
Operating pressure / control pressure	psi / bar	2,900 + 290 / 200 + 10				
Max. valve (front/center/rear) Profi / Profi Plus		2 / 3 / 5				
Max. hydraulic fluid capacity	gal / L	25 / 95				
Max. removable hydraulic fluid capacity	gal / L	21 / 80				

\* Specifications are manufacturer's estimates at time of publication and are subject to change without prior notification.

		720 Vario	722 Vario	724 Vario	726 Vario	728 Vario
<b>Flow Rates &amp; Lift Capacity</b>						
Flow rate control valves (1st valve)	gpm / lpm			37 / 140 (DUDK)		
Flow rate control valves (2nd valve)	gpm / lpm			37 / 140 (DUDK)		
Flow rate control valves (3rd valve)	gpm / lpm			37-45 / 140-170 (DUDK)		
Flow rate control valves (4th valve)	gpm / lpm			37-45 / 140-170 (DUDK)		
Flow rate control valves (5th valve)	gpm / lpm			37 / 140 (DUDK)		
Max. lifting capacity rear linkage	lb / kg			24,729 / 11,216		
Max. lifting capacity front linkage	lb / kg			11,914 / 5,404		

<b>Electrical Equipment</b>						
Batteries				1		
Battery power	Ah/V			180 / 12		
Alternator	V/A			14 / 240		
Max. portable current ISOBUS socket	A			60+25		

<b>Dimensions*</b>						
Track width rear	in / mm		73.6 / 1,870			78.7 / 2,000
Total width	in / mm			100.4 / 2,550		
Total length	in / mm			217.2 / 5,516		
Total height driver's cab w/standard tires w/o Fendt Guide	in / mm		123.7 / 3,142			126.1 / 3,202
Total height driver's cab w/standard tires w/Fendt Guide	in / mm		125.7 / 3,192			128.0 / 3,252
Max. ground clearance	in / mm			22.4 / 570		
Wheel base	in / mm			114.2 / 2,900		

\*720-724 Measurements based on 540/65R30 Fronts, 650/65R42 Rears

\*726-728 Measurements based on 540/65R34 Fronts, 650/85R38 Rears

<b>Weights</b>						
Empty weight (basic tractor w/cab-tanks full, w/o driver)	lb / kg			19,400 / 8,800		
Max. permissible gross weight	lb / kg			33,069 / 15,000		
Max. trailer hitch drawbar load	lb / kg			4,409 / 2,000		
Max. permissible front axle load	lb / kg			15,211 / 6,900		
Max. permissible rear axle load	lb / kg			25,353 / 11,500		

\* Specifications are manufacturer's estimates at time of publication and are subject to change without prior notification.

# FENDT



FENDT 700 VARIO GEN7.1 SERIES

 **AGCO** | **AGCO ANSWERS**  
Your Agriculture Company | (877) 525-4384 AGCOanswers@AGCOcorp.com

AGCO may at any time, and from time to time, for technical or other necessary reasons, modify any of the data, specifications or warranty of the products described herein. Some equipment shown may be optional. Attention: Photographs in this publication may show protective shields and guards open or removed for the purposes of illustration. Be certain all shields and guards are in place during operation.

© 2025 AGCO Corporation. Fendt is a worldwide brand of AGCO Corporation. AGCO®, Fendt®, Fendt Connect™, FendtONE™, Fendt iD™, TaskDoc® and VarioGrip™ are trademarks of AGCO. Bluetooth® is a trademark of Bluetooth SIG, Inc. All rights reserved.

FT25BRC013AGv02